

Timo

Design by IBEBI Lab





① Piano disponibile in diverse misure e forme.

② Struttura in tubo d'acciaio sezione 35x35 mm. Verniciatura epossipoliestere a polveri.

③ Meccanismo di apertura e chiusura gambe in alluminio pressofuso Nero RAL 9005.

④ Piedino regolabile in polipropilene (PP) nero.

⑤ Tappo copritesta in polipropilene (PP) nero.

① Table top available in different sizes and shapes.

② Steel tube frame 35x35 mm. Epoxy powder painting.

③ Black RAL 9005 diecast aluminium mechanism for opening and closing legs.

④ Adjustable black polypropylene (PP) plug.

⑤ Black polypropylene (PP) head cover.

① Plateau disponible en différentes tailles et formes.

② Structure en tube d'acier à section 35x35 mm. Vernis en poudre époxy-polyester.

③ Mécanisme de ouverture et fermeture piétements en aluminium brossé noir RAL 9005.

④ Embout réglable en polypropylène (PP) noir.

⑤ Bouchon en polypropylène (PP) noir.



Gancio in nylon grigio per unione piani (2 per tavolo). [Non per TIMO 120/140 D]

Grey linking device in nylon to join table tops (2 per table). [Not for TIMO 120/140 D]

Crochet en nylon gris pour union des plateaux (2 par table). Disponible uniquement pour la version à angle droits (RET) et forme trapézoïdale (TRA).

AGG10

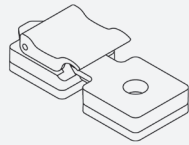
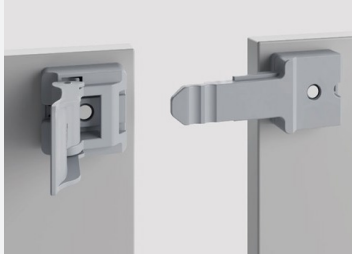

TIMO CARR

Carrello porta tavoli in tubo d'acciaio nero RAL 9005.

Impilabilità:
- Orizzontalmente max 8 tavoli
- Verticalmente max 7 tavoli

TIMO CARR

Black RAL 9005 steel tube frame trolley for tables.

Stackability:
- Horizontally max 8 tables
- Vertically max 7 tables

TIMO CARR

Chariot pour tables porteuses en tube d'acier noir RAL 9005.

Empilabilité:
- Horizontalement max 8 tables
- Verticalement max 7 tables

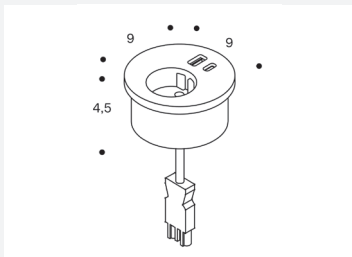

BOX09_A

Modulo singolo in tecnopolimero Nero con cover colorata* : 1x presa Schuko + 1x double USB charger (Type A+C). Versione da incasso, cavo di alimentazione con connettore GST.

Finiture Cover
Nero, Bianco, Verde, Azzurro, Giallo

BOX09_A

Single module in Black technopolymer with colored cover* : 1x Schuko socket + 1x double USB charger (Type A+C). Built-in version, power cable with GST connector.

Cover Finishes
Black, White, Green, Light Blue, Yellow

BOX09_A

Module unique en technopolymère Noir avec couvercle coloré* : 1x Schuko prise + 1x double USB charger (Type A+C). Version intégrée, câble d'alimentation avec connecteur GST.

Finitions Couvercle
Noir, Blanc, Vert, Bleu, Ciel, Jaune

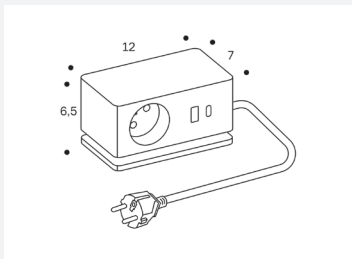

BOX10_A

Modulo singolo in tecnopolimero Nero o Bianco: 1x presa Schuko + 1x double USB charger (Type A+C). Versione con base in metallo, cavo di alimentazione 2 m con spina maschio schuko.

BOX10_A

Single module in Black or White technopolymer: 1x Schuko socket + 1x double USB charger (Type A+C). Metal base version, 2 m power cable with male Schuko plug.

BOX10_A

Module unique en technopolymère Noir ou Blanc: 1x Schuko prise + 1x double USB charger (Type A+C). Version avec base en métal, câble d'alimentation de 2 m avec prise Schuko mâle.

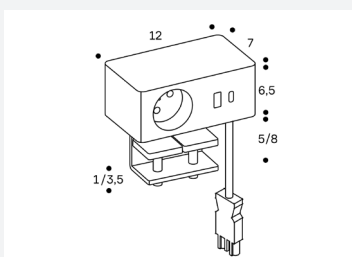

BOX10_B

Modulo singolo in tecnopolimero Nero o Bianco: 1x presa Schuko + 1x double USB charger (Type A+C). Versione con morsettiera, cavo di alimentazione con connettore GST18.

BOX10_B

Single module in Black or White technopolymer: 1x Schuko socket + 1x double USB charger (Type A+C). Version with terminal block, power cable with GST18 connector.

BOX10_B

Module unique en technopolymère Noir ou Blanc: 1x Schuko prise + 1x double USB charger (Type A+C). Version avec bornier, câble d'alimentation avec connecteur GST18.

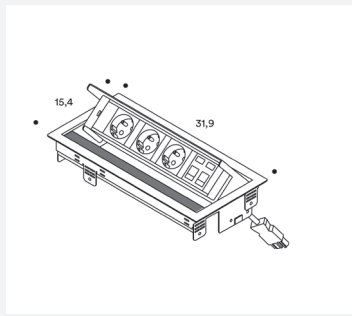

BOX02_B

Contenitore richiudibile in acciaio verniciato.

Finiture
Bianco RAL 9016
Nero RAL 9017
Grigio RAL 9006

4 moduli
- 3x prese elettriche uguali
- 2x RJ45

BOX02_B

Resealable painted steel box.

Finishes
White RAL 9016
Black RAL 9017
Grey RAL 9006

4 modules
- 3x same sockets
- 2x RJ45.

BOX02_B

Boîte en acier verni.

Finitions
Couvercle
Blanche RAL 9016
Noire RAL 9017
Grise RAL 9006

4 éléments
- 3 x mêmes prises électriques
- 2xRJ45.

Prese elettriche



Schuko



Schuko France



Schuko Italian (UNEL)



Danish



Swiss



British



American

Sockets

Prises électriques

Multimedia



Double USB charger (Type A+C)



USB 3.0 (Data)



HDMI



Mini Jack Stereo



RJ45 (CAT6)



VGA

Multimedia

Multimedia

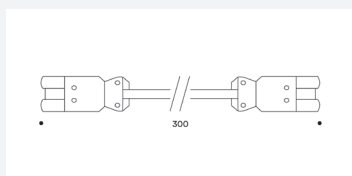

CONNECTION CABLE

Cavo di connessione tra moduli elettrici 2-3 mt (H05W-F 3G 1.5 mm² / GST18-GST18).

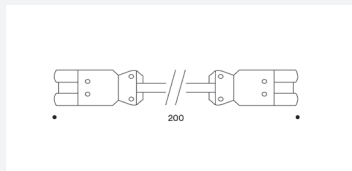

CONNECTION CABLE

Connection cable to joint variable plug power supply system 2-3 mt (H05W-F 3G 1.5 mm² / GST18-GST18).

CONNECTION CABLE

Câble de connexion entre éléments électriques 2-3mt (H05W-F 3G 1.5 mm² / GST18-GST18).

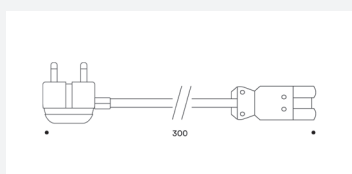

ELECTRIC CABLE

Cavo elettrico 2-3 mt (H05VV-F 3G 1.5 mm² / GST18-Spina Maschio).

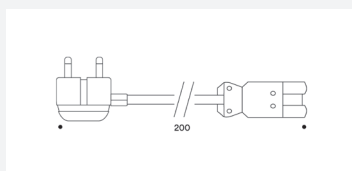

ELECTRIC CABLE

Electric cable 2-3 mt (H05VV-F 3G 1.5 mm² / GST18-Male Plug).

ELECTRIC CABLE

Câble électrique 2-3 mt (H05W-F 3G 1.5 mm² / GST18-Prise mâle).

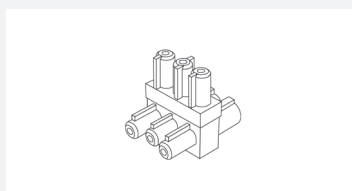

CAV_015

Distributore a 3 vie (Maschio/Maschio/Femmina).

CAV_015

Power distributor with 3 (Male/Male/Female).

CAV_015

Distributeur à 3 voies (Mâle/Mâle/Femelle).

Finiture

Finishes / Finitions

FINITURE PIANO

TABLE TOP FINISHES

FINITIONS PLATEAU

Truciolare rivestito Melaminico sp. 25 mm / MFC thk. 25 mm /
Agglomeré revêtu en Mèlaminé ép. 25 mm



U12
Bianco
White
Blanc

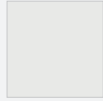

0FP
Grigio
Grey
Gris



0ON
Rovere chiaro
Light Oak
Chêne Clair

Truciolare rivestito Melaminico sp. 18 mm (FSC®) / MFC thk. 18 mm (FSC®) /
Agglomeré revêtu en Mèlaminé ép. 18 mm (FSC®)



U12
Bianco
White
Blanc



AS5
Noce Kiros
Walnut Kiros
Noyer Kiros

Truciolare rivestito Melaminico 3D sp. 22 mm / MFC 3D thk. 22 mm /
Agglomeré revêtu en Mèlaminé 3D ép. 22 mm



ST37
Rovere Nat
Oak Nat
Chêne Nat



S075
Quercia Grigia
Grey Oak
Chêne Gris



S074
Quercia Bianca
White Oak
Chêne Blanc



S073
Quercia Miele
Honey Oak
Chêne Miel

MDF laccato Perfect Sense sp. 22 mm / Lacquered MDF Perfect Sense thk. 22 mm /
MDF laqué Perfect Sense ép. 22 mm



U999
Nero
Black
Noir

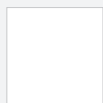

W1100
Bianco
White
Blanc



U727
Stone Grey



U961
Graphite Grey



U604
Reed Green

FINITURE STRUTTURA

Verniciato / Painted / Verni

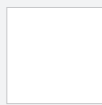

RAL 9003
Bianco
White
Blanc



RAL 9006
Grigio
Grey
Gris



RAL 9005
Nero
Black
Noir

FRAME FINISHES

FINITIONS STRUCTURE

Dimensioni Piano

Top Dimensions / Dimension du plateau

TIMO 100 Q

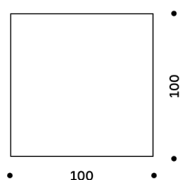

TIMO 140 R

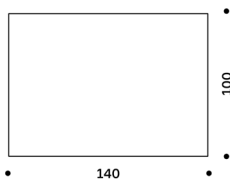

TIMO 160 R



TIMO 180 R

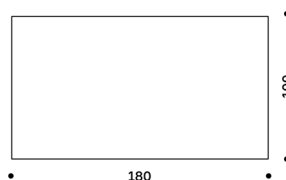

TIMO 120 D

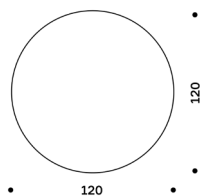

TIMO 140 D

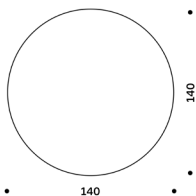

TIMO 140 S

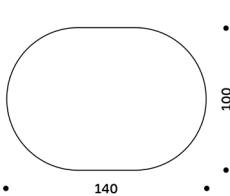

TIMO 160 S

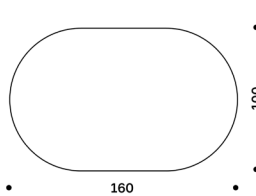

TIMO 180 S

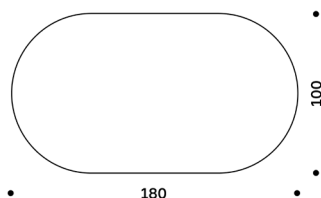

Disegni Tecnici

Technical Drawings / Dessins Technique

TIMO

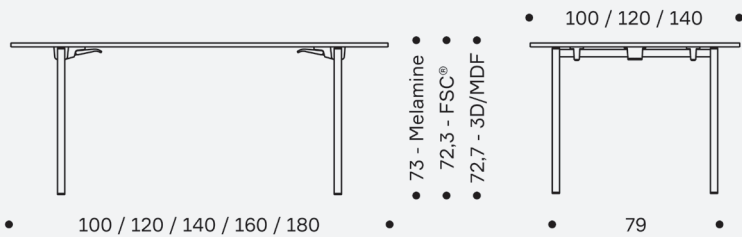

Note

Notes / Note

Pulizia

Per le parti metalliche consigliamo esclusivamente un panno morbido e alcool asciugando bene dopo la pulizia. Per le superfici in plastica, usare panno umido ed acqua con detersivo liquido neutro, non usare solventi, trielina, acetone o ammoniac.

Cleaning

For the metal parts we recommend only a soft cloth and alcohol, drying well after cleaning. For plastic surfaces, use a damp cloth and water with neutral liquid detergent, do not use solvents, trichlorethylene, acetone or ammonia.

Nettoyage

Pour les parties métalliques, nous recommandons uniquement un chiffon doux et de l'alcool, bien sécher après le nettoyage. Pour les surfaces en plastique, utilisez un chiffon humide et de l'eau avec un détergent liquide neutre, n'utilisez pas de solvants, de trichloréthylène, d'acétone ou d'ammoniac.

Garanzia

I nostri prodotti sono garantiti 5 anni (testo integrale della garanzia su richiesta). Un uso improprio del prodotto preclude la garanzia dello stesso.

Warranty

Our products are guaranteed for 5 years (full text of the guarantee on request). Improper use of the product precludes its warranty.

Garantie

Nos produits sont garantis 5 ans (texte complet de la garantie sur demande). Une mauvaise utilisation du produit exclut sa garantie.

Usa improprio

Non sono consentiti: Modifiche strutturali e/o manomissioni al prodotto.

Improper use

The following are not allowed: Structural changes and / or product tampering.

Utilisation incorrecte

Les éléments suivants ne sont pas autorisés : Modifications structurelles et/ou altération du produit.